



Sovitron Interior Pvt.Ltd.



**Model Name**

URBANA-21005 / DL-OSL-21005A-1

**Description**

Inground Light

**Technical description**

**Image**

**Dimension**

Outer Dia=50mm  
Cutout Dia=35mm  
H=52mm

**Frame**

Aluminum die cast

**Color Tempertaure**

5700K

**Power**

1.5W

**Total Luminous Flux**

98 lm

**Efficacy**

65.3 lm/W

**IP rating**

67

**Color Rendering**

≥80

**Mounting**

Buried

**Beam angle**

12,12.5,20,30,40 Degree

**Optics**

Tempered glass

**Dimming**

NON-Dimmable

**Operating Voltage**

220-240 VAC

**Standard Lifetime**

L70 minimum at 50,000  
burning hours



**Dimension diagram**

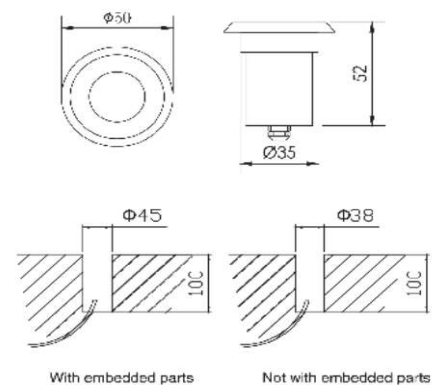

**Remarks:-**

Address: Plot #7 Saroorpur-Nangla Industrial Area,Ballabgarh-Sohna Road,Faridabad-121005

Email: [info@sovitron.com](mailto:info@sovitron.com)